



BTFO8-C1QM0282

HighLine

WIRE DRAW ENCODERS

SICK
Sensor Intelligence.



Illustration may differ



Ordering information

Type	Part no.
BTF08-C1QM0282	1068885

Included in delivery: AHM36A-S3CC014x12 (1), MRA-F080-102D2 (1)

Product is supplied fully assembled. See individual components for further technical data

Other models and accessories → www.sick.com/HighLine

Detailed technical data

Performance

BTF

Measurement range	0 m ... 2 m
Encoder	Absolute encoders
Resolution (wire draw + encoder)	0.01 mm ^{1) 2)}
Repeatability	≤ 1 mm ³⁾
Linearity	≤ ± 2 mm ³⁾
Hysteresis	≤ 2 mm ³⁾

¹⁾ The values shown have been rounded.

²⁾ Example calculation based on the BTF08 with PROFINET: 200 mm (wire draw length per revolution - see Mechanical data): 262,144 (number of steps per revolution) = 0.001 mm (resolution of wire draw + encoder combination).

³⁾ Value applies to wire draw mechanism.

Interfaces

BTF

Communication interface	CANopen
Programmable/configurable	✓

Electrical data

BTF

Connection type	Male connector, M12, 5-pin, universal
Supply voltage	10 V ... 30 V
Power consumption	≤ 1.5 W (without load)
MTTFd: mean time to dangerous failure	270 years (EN ISO 13849-1) ¹⁾

¹⁾ This product is a standard product and does not constitute a safety component as defined in the Machinery Directive. Calculation based on nominal load of components, average ambient temperature 40 °C, frequency of use 8760 h/a. All electronic failures are considered hazardous. For more information, see document no. 8015532.

Mechanical data

BTF

Measuring wire material	Highly flexible stranded steel 1,4401 stainless steel V4A
Weight (measuring wire)	7.1 g/m
Housing material, wire draw mechanism	Aluminum (anodized), zinc die cast
Spring return force	6 N ... 14 N ¹⁾
Length of wire pulled out per revolution	200 mm
Life of wire draw mechanism	Typ. 1,000,000 cycles ^{2) 3)}
Actual wire draw length	2.2 m
Wire acceleration	40 m/s ²
Operating speed	8 m/s
Mounted encoder	AHM36 CANopen, AHM36A-S3CC014X12, 1065999
Mounted mechanic	MRA-F080-102D2, 6028625

¹⁾ These values were measured at an ambient temperature of 25 °C. There may be variations at other temperatures.

²⁾ Average values, which depend on the application.

³⁾ The service life depends on the type of load. This is influenced by environmental conditions, the installation location, the measuring range in use, the traversing speed, and acceleration.

Ambient data

BTF

EMC	According to EN 61000-6-2 and EN 61000-6-3
Enclosure rating	IP64
Operating temperature range	-30 °C ... +70 °C

Classifications

ECl@ss 5.0	27270590
ECl@ss 5.1.4	27270590
ECl@ss 6.0	27270590
ECl@ss 6.2	27270590
ECl@ss 7.0	27270590
ECl@ss 8.0	27270590
ECl@ss 8.1	27270590
ECl@ss 9.0	27270590
ECl@ss 10.0	27270613
ECl@ss 11.0	27270503
ETIM 5.0	EC001486
ETIM 6.0	EC001486
ETIM 7.0	EC001486
UNSPSC 16.0901	41112113

Dimensional drawing (Dimensions in mm (inch))

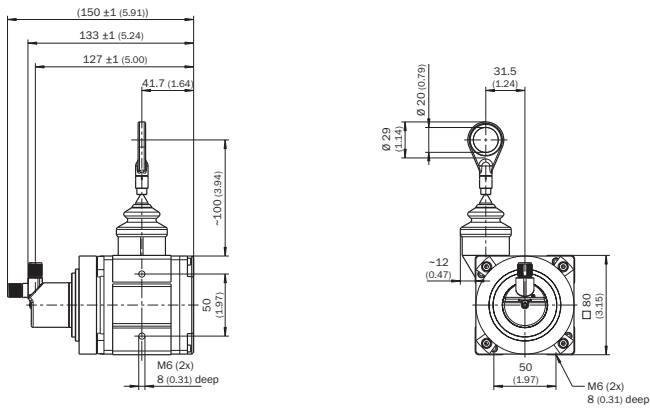

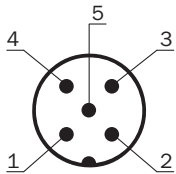

PIN assignment

















PIN	Signal	Wire colors (cable connection)	Function
1	CAN Shield	White	Screen
2	VDC	Red	Supply voltage Encoder 10 V DC ... 30 V DC
3	GND/CAN GND	Blue	0 V (GND)
4	CAN high	Black	CAN signal
5	CAN low	Pink	CAN signal
Housing	-	-	Screen

Recommended accessories

Other models and accessories → www.sick.com/HighLine

	Brief description	Type	Part no.
Flanges			
	Flange adapter for HighLine wire draw mechanisms, adaption of face mount flange with centering hub 20 mm to 50 mm servo flange, Aluminum, including 3 countersunk screws M4 x 10	BEF-FA-020-050WDE	2073776
Other mounting accessories			
	Joint ball for later insertion in wire end ring with 20 mm diameter. The use of this joint ball enables movement in multiple levels of freedom.	Joint protection for wire rope BTF/PRF/MRA	5318683

	Brief description	Type	Part no.
	Compressed air attachment for MRA-F080... and MRA-F130... HighLine wire draw mechanism	MRA-F-P	6073769
	Additional brush attachment for wire draw mechanism MRA-F080 (2 m and 3 m from HighLine series)	MRA-F080-B	6045341
	Wire draw deflection pulley for wire draw mechanism MRA-F080 (2m and 3m from HighLine series)	MRA-F080-R	6028632
Adapters and distributors			
	T-piece for simultaneous connection to sender and receiver, splits the cable from the control cabinet to the sender and receiver, 5-pin	DSC-1205T000025KM0	6030664
	Y-CAN cable	Y-CAN cable	6027647
Plug connectors and cables			
	Head A: Flying leads Head B: Flying leads Cable: CANopen, DeviceNet™, shielded Wire shield Al-Pt film, overall shield C-screen tin-plated	LTG-2804-MW	6028328
	Head A: female connector, M12, 5-pin, straight Head B: Flying leads Cable: CANopen, DeviceNet™, shielded, 2 m A-coded	DOL-1205-G02MY	6053041
	Head A: female connector, M12, 5-pin, straight Head B: Flying leads Cable: CANopen, DeviceNet™, shielded, 5 m A-coded	DOL-1205-G05MY	6053042
	Head A: female connector, M12, 5-pin, straight Head B: Flying leads Cable: CANopen, DeviceNet™, shielded, 10 m A-coded	DOL-1205-G10MY	6053043
	Head A: female connector, M12, 5-pin, straight Head B: male connector, M12, 5-pin, straight Cable: CANopen, DeviceNet™, PUR, halogen-free, shielded, 2 m A-coded	DSL-1205-G02MY	6053044
	Head A: female connector, M12, 5-pin, straight Head B: male connector, M12, 5-pin, straight Cable: CANopen, DeviceNet™, PUR, halogen-free, shielded, 5 m A-coded	DSL-1205-G05MY	6053045
	Head A: female connector, M12, 5-pin, straight Head B: male connector, M12, 5-pin, straight Cable: CANopen, DeviceNet™, PUR, halogen-free, shielded, 10 m A-coded	DSL-1205-G10MY	6053046
	Head A: female connector, M12, 5-pin, straight Cable: CANopen, DeviceNet™, shielded	DOS-1205-GA	6027534
	Head A: male connector, M12, 5-pin, straight, A-coded Cable: CANopen, DeviceNet™, shielded	STE-1205-GA	6027533
	Head A: male connector, M12, 5-pin, straight Cable: CANopen, unshielded	STE-1205-GKEND	6037193

	Brief description	Type	Part no.
	Head A: male connector, M12, 5-pin, straight Cable: CANopen, unshielded	CAN male connector	6021167
Programming and configuration tools			
	Hand-held programming device for the programmable SICK AHS/AHM36 CANopen encoders, TMS/TMM61 CANopen inclination sensors, TMS/TMM88 CANopen, TMS/TMM88 Analog, and wire draw encoders with AHS/AHM36 CANopen. Compact dimensions, low weight, and intuitive operation.	PGT-12-Pro	1076313
Wire draw mechanism			
	HighLine wire draw mechanism for servo flange with 6 mm shaft, measuring range 0 m ... 2 m	MRA-F080-102D2	6028625

SICK AT A GLANCE

SICK is one of the leading manufacturers of intelligent sensors and sensor solutions for industrial applications. A unique range of products and services creates the perfect basis for controlling processes securely and efficiently, protecting individuals from accidents and preventing damage to the environment.

We have extensive experience in a wide range of industries and understand their processes and requirements. With intelligent sensors, we can deliver exactly what our customers need. In application centers in Europe, Asia and North America, system solutions are tested and optimized in accordance with customer specifications. All this makes us a reliable supplier and development partner.

Comprehensive services complete our offering: SICK LifeTime Services provide support throughout the machine life cycle and ensure safety and productivity.

For us, that is “Sensor Intelligence.”

WORLDWIDE PRESENCE:

Contacts and other locations –www.sick.com